



Research
Tunnel Engineering—Article

A Closer Look at the Design of Cutterheads for Hard Rock Tunnel-Boring Machines

Jamal Rostami^{a,*}, Soo-Ho Chang^b

^aExcavation Engineering and Earth Mechanics Institute, Department of Mining Engineering, Colorado School of Mines, Golden, CO 80401, USA

^bGeotechnical Engineering Research Institute, Korea Institute of Civil Engineering and Building Technology, Goyang 10223, Korea

ARTICLE INFO

Article history:

Received 2 May 2017

Revised 15 August 2017

Accepted 22 September 2017

Available online 12 December 2017

Keywords:

TBM cutterhead design

Cutterhead layout

Disk cutters

Cutting pattern

TBM efficiency

ABSTRACT

The success of a tunnel-boring machine (TBM) in a given project depends on the functionality of all components of the system, from the cutters to the backup system, and on the entire rolling stock. However, no part of the machine plays a more crucial role in the efficient operation of the machine than its cutterhead. The design of the cutterhead impacts the efficiency of cutting, the balance of the head, the life of the cutters, the maintenance of the main bearing/gearbox, and the effectiveness of the mucking along with its effects on the wear of the face and gage cutters/muck buckets. Overall, cutterhead design heavily impacts the rate of penetration (ROP), rate of machine utilization (U), and daily advance rate (AR). Although there has been some discussion in commonly available publications regarding disk cutters, cutting forces, and some design features of the head, there is limited literature on this subject because the design of cutterheads is mainly handled by machine manufacturers. Most of the design process involves proprietary algorithms by the manufacturers, and despite recent attention on the subject, the design of rock TBMs has been somewhat of a mystery to most end-users. This paper is an attempt to demystify the basic concepts in design. Although it may not be sufficient for a full-fledged design by the readers, this paper allows engineers and contractors to understand the thought process in the design steps, what to look for in a proper design, and the implications of the head design on machine operation and life cycle.

© 2018 THE AUTHORS. Published by Elsevier LTD on behalf of Chinese Academy of Engineering and Higher Education Press Limited Company. This is an open access article under the CC BY license (<http://creativecommons.org/licenses/by/4.0/>).

1. Introduction

A tunnel-boring machine (TBM) is a “tunnel-production factory”; as such, all parts of the production line should be functional in order to make the final product, which is the next meter of excavated tunnel. TBMs have existed since the mid-19th century, both in concept and in reality, and have been an integral part of the tunneling industry since the 1950s. The continuous improvement of TBMs and their capabilities since their introduction, especially in the past two decades, has made them the method of choice in many tunneling projects longer than ~1.5 km. Of course, other issues related to the tunnel application or ground conditions may change this choice, and may require the use of competing systems such as drill and blast and/or the use of the sequential excavation method (SEM), also known as the new Austrian tunneling method (NATM), which primarily uses roadheaders.

Although the selection and choice of TBM specifications appear to be straightforward, this seemingly simple task has proven to be challenging in several projects [1]. Problematic situations include deep tunnels, where shield machines can be used but risk getting trapped, and mixed ground conditions, where the choice of open-type machines for higher cutting speed has resulted in dramatic setbacks. In any case, the choice of machine type and specifications overshadows the operation of the machine and its performance during tunnel construction. Thus, it is critical to understand the implications of the choice of various machine types and related specifications when estimating the potential performance of tunneling machines. Although the choice of machine type is very important to the success of an operation, the design of the cutterhead is the single most critical part of the TBM operation, irrespective of the type of machine. This is because the TBM cutterhead is the “business end” of the machine—the place where the cutting tools meet the rock for the first time.

Designing the cutterhead involves the following factors: the choice of the cutter type, spacing of the cutters for the given geology along the tunnel, cutterhead shape and profile, balance of the

* Corresponding author.

E-mail address: rostami@mines.edu (J. Rostami).

head, efficient mucking, position and design of the muck buckets, access to the face and allotted space for letting miners reach the face, consideration for the structural joints and assembly of the head, and cutting clearance for the cutters and the body of the TBM. Each of these design parameters has some implication for the efficiency of the cutting process as well as the maintenance of the cutters, cutterhead, and cutterhead support. Another issue with the design of the head is the smooth operation and balance of the head, which allows for better steering of the machine, especially in mixed face conditions.

Despite the importance of the cutterhead design of a TBM, the amount of published literature on this subject is very limited [2]. This is because cutterhead design is mainly performed by the machine manufacturers, and the end-users often do not get involved with this level of detail. There has been limited academic interest on this topic due to a lack of opportunity to perform tests or follow normal procedures to validate hypotheses or obtain results. As a result, it is difficult to design different cutterheads and try them on an equal basis in order to assess their field performance or compare their design implications. Miniaturization of the head to assess its performance is not very attractive because rock excavation is widely viewed as not being scalable. On a large and full scale, it is very rare for a project to allow significant changes or modifications to the cutterhead design, unless something drastic happens. This is because it is very expensive and time-consuming to change the cutterhead in the field, so alterations are often limited to structural repairs and minor modifications of the mucking system.

Some activity on this topic has taken place in recent years, as the TBM market seems to be growing in Asia. Research on this topic has mainly taken place in the state key laboratories in China, and has also been done by researchers in Turkey and Korea [1,3–6]. The focus of these activities has been to make the machines more effective, primarily to address the dire need and pressure to improve the speed of tunneling and increase efficiency. However, some of the work in the past has focused on modeling without a discussion of design steps [7,8], while other work has looked at the design from a purely mechanical engineering point of view, without an in-depth discussion of rock behavior as it pertains to cutterhead design and machine operation [9]. This paper is intended to shed some light on the topic and to cover some basic principles of the cutterhead design procedure for hard rock TBMs. The content is not intended to be a discussion of a specific research project; rather, it is a reflection on the experiences of the primary author in cutterhead design during the past two decades.

2. Cutterhead design in simple steps

This section offers an overview of cutterhead design in terms of simple steps to allow the reader to understand the process and be able to evaluate the critical design issues when dealing with the acquisition of a new rock TBM or the refurbishment of an existing machine for a given tunnel geology.

2.1. Cutter selection

The first step in the process of cutterhead design and in the evaluation of a TBM for a project with a given geology is cutter selection. More information and a general guide on cutter selection for rock-cutting applications can be found in a paper by Rostami [10]. In addition, a discussion on various disk cutters and general trends in the application of disk cutters can be found in other publications [11,12]. The trend in the industry has been to use 432 mm (17 in) diameter constant cross-section (CCS) disk cutters as the base choice in various applications, especially on hard rock TBMs.

An exception has been the use of larger 483 mm (19 in) disk cutters on TBMs working on very hard and abrasive rock, in order to minimize the need for cutter replacement. Another exception has been the use of >500 mm (20 in) disk cutters on TBMs larger than 10.5 m in diameter [12,13]. Smaller cutters, such as 150 mm, 300 mm, and 365 mm cutters, are used for smaller cutterheads. The implications of the disk cutter size are as follows:

(1) **Cutter load capacity.** This determines the depth of penetration. The typical load capacities of the 432 mm and 483 mm cutters are 250 kN and 310 kN, respectively.

(2) **Required cutting forces.** These increase with the size of the cutter for the same rock type.

(3) **Cutter velocity limit.** This is imposed by the maximum allowed rotational speed of the bearings. The typical velocity limits are 165 m·min⁻¹ and 200 m·min⁻¹ for 432 mm and 483 mm disk cutters, respectively.

Note that the cutterhead rotational speed (measured in revolutions per minute) on hard rock TBMs is a function of the disk cutter size and velocity limit, and the diameter of the TBM, as follows:

$$V_R = V_L / (\pi D_{TBM}) \quad (1)$$

where V_R or RPM is the rotational speed of the cutterhead in r·min⁻¹, V_L is the velocity limit in m·min⁻¹ (based on the cutter diameter, as noted above), and D_{TBM} is the machine diameter in m. Larger cutters typically have higher velocity limits and are suitable for larger TBMs. A higher cutterhead rotational speed means a higher rate of penetration (ROP), assuming that the machine power is sufficient.

The cutter tip width, T , is another parameter to be selected; this controls the cutting forces, F , in an almost linear fashion ($F \sim T$). The typical tip width varies from 12.5 mm to 25 mm. The higher the capacity of the cutter and the higher the strength and abrasivity of the rock, the higher tip width is needed.

2.2. Cut spacing

The second step in cutterhead design involves the selection of the cutting geometry, including the spacing and location of the cutters on the profile. Selection of the spacing and penetration is a function of the cutting forces. Although the allowable cutter load is the first parameter to check when selecting the cutting geometry, it is necessary to keep in mind that an overall check of the TBM thrust, torque, and power may be needed in order to verify the assumption of the penetration at the end of the design cycle.

Optimum spacing is a concept that has been discussed in the literature; it refers to the spacing at which the required energy of rock cutting/excavation is minimized for a given depth of penetration [14]. The most common measure of optimization is the use of specific energy (SE), which is the amount of energy required to excavate a unit volume of rock. SE is typically expressed in hp·h·cyd⁻¹ (1 hp = 745.700 W), hp·h·ton⁻¹, kW·h·m⁻³, or in similar units that express energy per volume or weight of excavated rock. It has been proven that the magnitude of SE is minimized when plotted against the spacing-to-penetration (S/P) ratio. The range of S/P ratios that require a minimum SE, or a so-called optimum S/P ratio for disk cutters, is typically within 10–20, although it has been reported to be as low as 6 and as high as 40. The optimum range of S/P ratio is a function of rock type; it increases with rock brittleness and can change slightly with varying penetration. However, for the most part and for practical design, an S/P ratio of 10–20 is often used in order to select the optimum spacing for a given range of penetration. For example, if the anticipated penetration is about 5 mm·r⁻¹, which is typical for granitic rock, the range of optimum spacing is between 50 mm and 100 mm. In general, however, in order to avoid ridge buildup in high-strength and tough rocks, a spacing of 75–100 mm is selected for most cutterhead

designs. It should be noted that the cut spacing should be selected based on the hardest/strongest rock on the alignment (if present over a notable section of the tunnel, rather than only in short distances of dikes or intrusions). Other approaches for the selection of cut spacing exist [6,14], which involve direct measurement of forces and experiments.

The optimum spacing can be as high as 110 mm in softer, more brittle rocks such as sandstone and limestone. To determine optimum spacing in a more systematic way, it is prudent to evaluate the cutting forces based on the selected disk geometry (diameter and tip width) and the rock physical properties. Various formulas and models have been developed and introduced for this purpose; these can be used at this stage to assist in determining the most probable depth of penetration that can be achieved under the given circumstances. One of the most frequently used formulas for the estimation of cutting forces acting on disk cutters is the “Colorado School of Mines (CSM) model” [14,15], which estimates cutting forces as follows:

$$F_t = CTR\varphi \left(\frac{\sigma_c^2 \sigma_t S}{\varphi \sqrt{RT}} \right)^{1/3} \quad (2)$$

where F_t is the total force acting on the disk (N); C is a constant equal to 2.12; T is the cutter tip width (mm); R is the cutter radius, which is half of the cutter diameter; σ_c is the uniaxial compressive strength (UCS) of the rock (MPa); σ_t is the Brazilian indirect tensile strength (BTS) of the rock (MPa); S is the cut spacing (mm); and φ is the angle of the contact area, estimated as $\varphi = \cos^{-1} \left(\frac{R-p}{R} \right)$, where p is the cutter penetration (mm).

Individual cutting forces can be estimated as follows: normal force $F_N = F_t \cos \beta$, and rolling force $F_R = F_t \sin \beta$, where $\beta = \varphi/2$ and the cutting/rolling coefficient (RC) is the ratio of the rolling to normal forces, or $RC = F_R/F_N = \tan \beta$.

The estimated forces can be used as a measure to find the maximum penetration into the rock within the cutter load capacity for the selected disc, and hence the spacing from the abovementioned S/P ratio. Users can use other formulas for estimating cutting forces as per Refs. [16–21].

2.3. Shape of the cutterhead

TBM cutterheads can have a cone, dome, or flat shape. Cone and dome shape cutterheads have gradually been phased out, and new machines primarily use flat-profile cutterheads. The flat-profile cutterhead (Fig. 1) [22] has proven to be more efficient, easier, and more convenient to maintain; it also accommodates back-loading cutters for cutter change from within the cutterhead. The end of the head is curved in order to allow the gage cutters to cut clearance for their hub and the cutterhead support/shield.

2.4. Cutterhead profile

A detailed cutterhead design starts with the development of the cutterhead profile. The profile is the cross-section of the face where the cutters excavate the rock and leave marks of their tracks. An example of a TBM cutterhead profile is given in Fig. 2. Developing a cutterhead profile simply means that the location of the cutters on a half cut of the face is defined and quantitatively expressed. This involves providing the coordinates of the tip of the cutters using a Cartesian coordinate system (e.g., an X–Z system, where Z is the tunnel axis). In addition to the location of the cutter tips, the orientation or tilt angle of the cutters must be defined.

The process of cutterhead profile design starts with assigning the location of the first cutter from the center and continues with allocating all the subsequent cutters relative to the previous ones. For this purpose, the notion of cutter spacing can be used. The cut



Fig. 1. A flat-profile cutterhead with back-loading cutters [22].

or cutter spacing, as discussed earlier, is the lateral distance between the cutters. It can be expressed in linear terms, from the center point of the tip of one cutter to the next. Alternatively, it can be expressed in terms of the distance between the cutters in a radial direction (i.e., radius from center). Fig. 3 shows the difference between the two spacing terminologies. In the flat area of the head, the linear and radial spacings are identical, or $S_{Ri} = S_{Li}$. However, in the curved area of the cutterhead, the radial spacing, S_{Rk} , is a projection of the linear spacing, S_{Lk} , on the plane that passes through the center of the profile and is perpendicular to the machine axis (i.e., the face plane), so $S_{Rk} = S_{Lk} \cos \alpha_k$, or $S_{Rk} = \sqrt{S_{Lk}^2 - Z_k^2}$. The location of the cutters relative to the center of rotation is determined as: $R_{i+1} = R_i + S_{Ri}$, ..., $R_{k+1} = R_k + S_{Rk} = R_k + S_{Lk} \cos \alpha_k$ and ultimately as follows:

$$R_N = R_{TBM} = D_{TBM}/2 = \sum_{i=1}^N S_{Ri} \quad (3)$$

where S_{Ri} is the radial spacing between cutter i and $i+1$, S_{Li} is the linear spacing between cutter i and $i+1$, S_{Rk} is the radial spacing between cutter k and $k+1$, S_{Lk} is the linear spacing between cutter k and $k+1$, R_i is the radial distance of cutter i from the center, R_{i+1} is the radial distance of cutter $i+1$ from the center, Z_k is the offset of cutter k from a plane of reference (distance from the face along the tunnel axis), R_{TBM} is the radius of the TBM, and D_{TBM} is the diameter of the TBM.

Geometric equations can be used to estimate Z_k and S_{Rk} from S_{Lk} using the tilt angle α_k as follows:

$$S_{Rk} = S_{Lk} \cos \alpha_k = \sqrt{S_{Lk}^2 - Z_k^2} \quad (4)$$

$$Z_k = S_{Lk} \sin \alpha_k = \sqrt{S_{Lk}^2 - S_{Rk}^2} \quad (5)$$

The TBM diameter, D_{TBM} , is the sum of all the radial spacings multiplied by two (see Eq. (3)). N is the number of cutters on the cutterhead; this can be found using various formulas, but for the detailed cutterhead design, it is determined by the actual cutter allocation on the profile. Some of the formulas used for estimation of the number of cutters are as follows:

$$N = \frac{D_{TBM}}{2S} + K \quad \text{or} \quad N = \frac{D_{TBM} - 500}{2S} + 15 \quad (6)$$

where S is the selected optimum spacing (in mm, where D_{TBM} is also in mm), and K is a factor that accounts for smaller spacings at the gage, and that can range from 8 to 12 depending on the machine diameter. The calculated number of cutters can be checked with published literature [23].

Angle α , or the tilt angle, is the angle between the direction of the disk cutter centerline (i.e., the plane that goes through the ring)

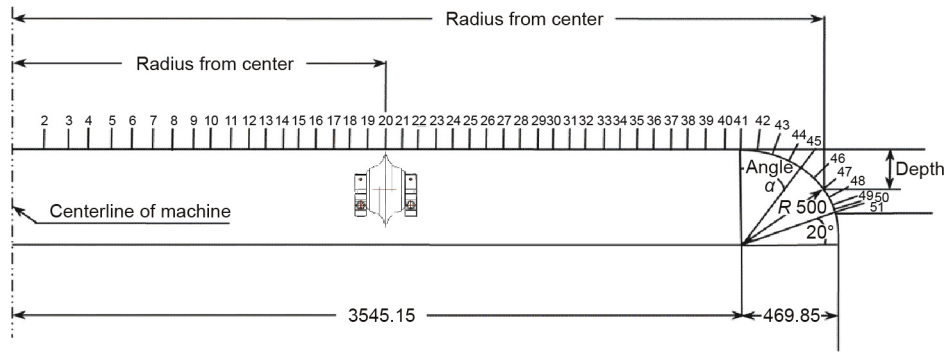

Fig. 2. A typical cutterhead profile for a hard rock TBM with a flat profile (units: mm) (courtesy of The Robbins Company).

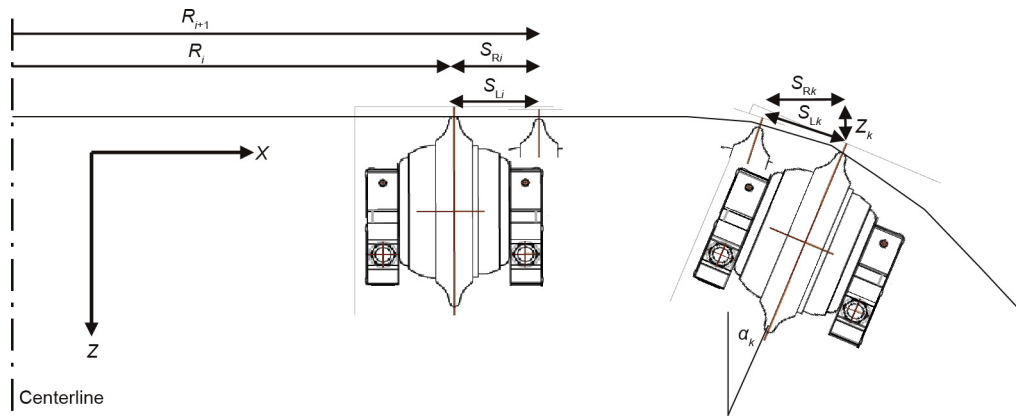

Fig. 3. Schematic drawing of the profile and definition of linear and radial spacing.

and the tunnel axis. As such, $\alpha = 0^\circ$ for the cutters that are perpendicular to the flat face (i.e., the plane that is normal to the tunnel axis). This is typically the case for the cutters at the center of the cutterhead and the face. As the transition and gage cutters start and the profile enters a curvature, α typically increases to $65^\circ\text{--}70^\circ$. The purpose of the tilt angle is twofold: ① For cutters that are at the outer gage, the tilt angle cuts a clearance for the hub and cutter mounting assembly; and ② for the rest of the cutters in the gage area, the tilt angle ensures that the cutters are perpendicular to the face at the point of contact (within the curved section of the profile in the gage area). The second requirement ensures the endurance of the cutters, since full-scale laboratory testing has shown that the side force that is acting on the cutter is minimized when the cutter is perpendicular to the face it is cutting at the point of contact, and increases when the cutter has an angle relative to the surface that it cuts. This is shown in Fig. 4.

In practice, the first four disk cutters are combined in a set called the “center quad.” This is because of the lack of space at the center, where there is no room for the installation of individual cutters, and because the mounting assembly (hub) for the cutters does not allow the placement of the cutters in such a way that the desired spacing can be reached. Fig. 5 shows a picture of a center quad along with a schematic example of center quad positioning in which reasonable spacing is achieved. The distance between the blades in the quad set is typically fixed; by allocating one of the inner cutters at a certain distance from the center, the others will automatically assume a spacing and thus radius from the center. For example, if the distance between the center quad disks is 200 mm, when one of the inner blades is positioned at a radius of 50 mm, the second blade automatically assumes a radius of 150 mm from the center, which means a spacing of 100 mm from the first one. The third will be located at a distance of 250 mm from

the center, which implies a spacing of 100 mm from the second cutter track, and the fourth cutter will be located at a radius of 350 mm from the center, which means a spacing of 100 mm from the third cutter track. This takes care of the first four cutters and the first three spacings. Of course, for harder rock, the spacing of the cutters can be reduced by 10–15 mm in the center quad, which will reduce the spacing of the center cutters to 85–90 mm.

There are other arrangements for the center in which six cutters are placed together; however, the overall arrangement is the same as that of the quad, except that there are six cutters instead of four. Other cutters can be allocated along the line of the profile based on the assigned (optimum) spacings. This means that when a quad is allocated, the fifth cutter can assume a radius of about 450 mm (assuming a 100 mm spacing between the fourth and fifth cutters). Given the clearances of the cutter housing, the cutter can be allocated to the area adjacent to the center quad without much interference. The same applies for the sixth cutter and onward. Thus, these cutters in the so-called face area can be allocated to the profile without much of a problem, until they reach the transition and gage area. The cutter tilt angles start at the transition area, and the offset from the face also increases (coordinate Z of the cutter tip). Some of the new flat-type heads have a very small transition area, meaning that only one or two cutters are present in the transition, and then the gage curve starts.

To allocate the cutters in the gage area, once the curvature of the head is established, cutters can be assigned to follow this curvature at an angle of about $\alpha_{\max} = 65^\circ\text{--}70^\circ$ (see the α angle in Fig. 2). As noted before, the typical curvature radius of a flat cutterhead is 450–550 mm. This provides sufficient curvature to allow for a gradual transition to gage cutters and to cut clearance for the cutterhead and cutter mounting assemblies. The cutters in the gage area are placed on the curvature at line spacings that

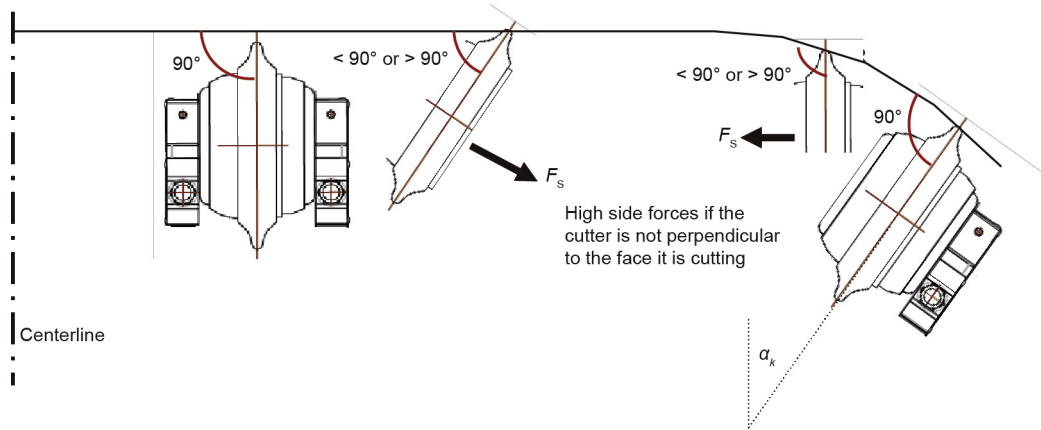

Fig. 4. Schematic drawing of the profile and definition of tilt angle.

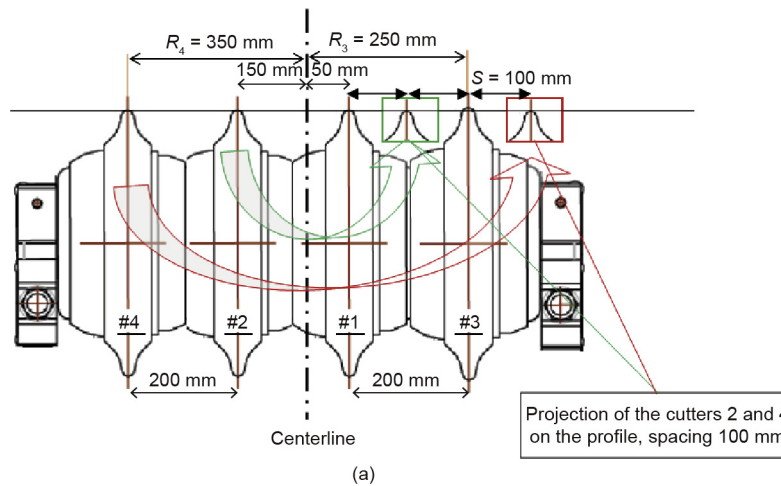

Fig. 5. (a) Schematic drawing and (b,c) pictures of the center quad (pictures from The Robbins Company).

are progressively smaller than the line (radial) spacing at the face. For example, the line spacing (which along the curve is the chord) of 100 mm at the face will be gradually reduced by 5–4 mm in every iteration (i.e., $S_{L(k+1)} = S_{Lk} - 5$). For every position, the cutter should be tilted to match the curvature at the point of contact (i.e., it should be perpendicular to the curvature or the tangent line at that point). Allocating the cutters along the curvature means

that the radial spacing will decrease at a faster rate (due to the tilt angle).

The number of cutters at the gage area is a function of the hardness of the rock and of how conservative the designer wants to be in protecting the gage cutters. It is necessary to keep in mind that in addition to the load of the regular cutters along the face, the gage cutters must go through the pile of muck at the face, which

causes additional load and wear. For these reasons, the spacing of the cutters in the gage area is reduced to relieve these cutters and reduce the extraneous stresses on them. Given the radius of the curvature of the gage area—which could be 500 mm, for example—the length of the section of the curve (arc) would be around:

$$L_{Gage} = R_{Gage} \alpha_{max} \tag{7}$$

where L_{Gage} is the length of the curvature of the gage area along the arc, R_{Gage} is the radius of the curvature of the gage area, and α_{max} is the maximum tilt angle or the tilt angle of the last gage cutter (in radians).

Fig. 6 shows the profile for the given cutterhead, which has nearly 30 cutters and a diameter of about 4400 mm in this case.

Additional cutters can be placed on the gage, and particularly at the last position. These cutters are called “copy cutters” and are effectively placed on the profile at the location of the last cutter to provide relief to the last cutter, thus ensuring that the diameter of the tunnel is not reduced due to wear on the gage cutters. Although machines designed for softer and less abrasive rocks do not typically have copy cutters, TBMs used in harder, more abrasive (igneous or granitic) rocks have one copy cutter—that is, there are two cutters per position in the last spot. It is a common practice to use cutters with a wider tip or disks with a carbide insert in the gage cutters at the last ~2–3 positions, in order to ensure that the cutting diameter is not compromised. Some machines also have one or two cutters that are mounted on an assembly and that can be extruded by 10–25 mm beyond the nominal profile

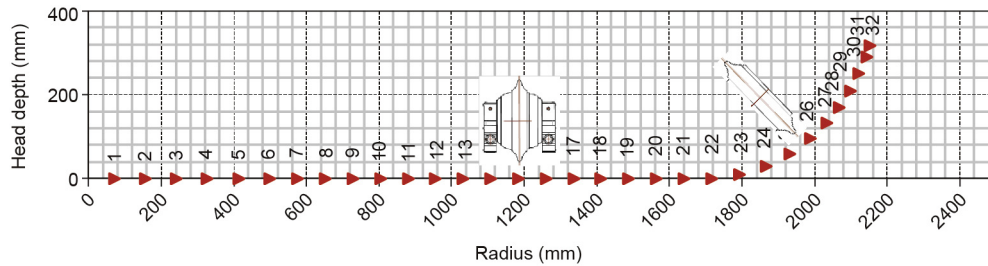

Fig. 6. Cross-sectional profile for the example cutterhead.

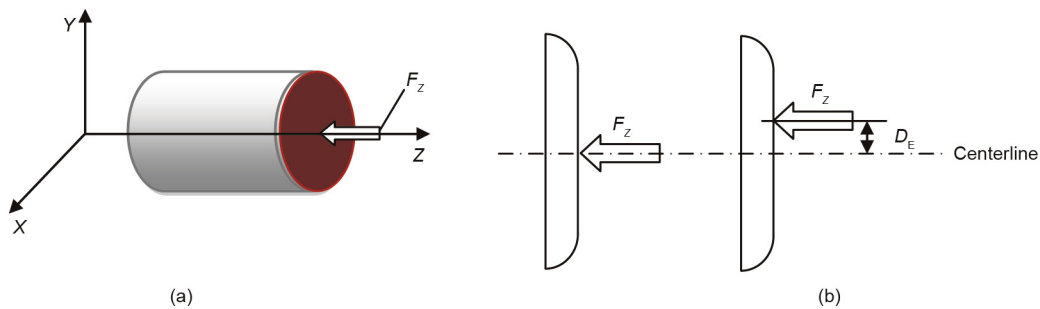

Fig. 7. Schematic drawing of the resultant force relative to the cutterhead: (a) centered; (b) eccentric.

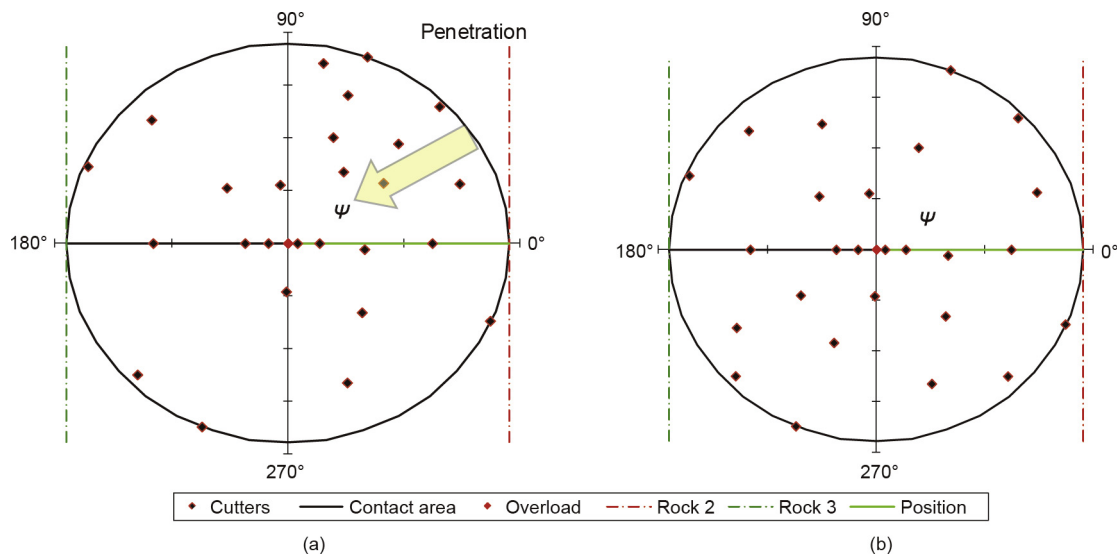

Fig. 8. Cutter distribution on a cutterhead with (a) a cluster in the 0°–90° quarter, and the resultant force (exaggerated) and (b) a more reasonable and uniform distribution. The yellow arrow in (a) indicates the area of high cutter concentration.

(bored diameter). These cutters can be used for overcut on single or double shield machines to avoid jamming due to ground convergence. They can also cut a relief slot for the gage cutter in case of excessive wear on the gage disks, which can result in a reduced tunnel diameter. In such cases, this slot is needed to avoid overloading the gage cutters in the first few rotations after the changing of the old cutter, or even to make room for the installation of the old cutters, which otherwise cannot be secured in place, especially in back-loading cutterheads.

2.5. Cutter distribution on the cutterhead

With the profile of the head selected and the position of the cutters (i.e., the cutter radius and tilt angles) defined, the next question is how to spread the cutters around the head for a uniform distribution. The implications of the distribution of the cutters around the head are the balance of the cutterhead in uniform material and, more importantly, the balance of the resultant forces in mixed ground conditions and the magnitude of side loading on the disk cutters. For a given profile, if the cutters are clustered in a certain location on the head, they can cause unbalanced and eccentric forces. In these cases, the resultant force is away from the center of the cutterhead, resulting in non-uniform loading of the main bearing. Eccentric forces are caused by the summation or superimposition of the cutting forces of various disk cutters. If the cutterhead is fully balanced, it will ideally create a resultant force that is parallel to the tunnel/TBM axis and at the center. If there is a shift in the resultant force causing it to move away from the axis of rotation, or if the resultant force is at an angle to the machine axis, it causes moments relative to the X and Y axes that are undesirable and detrimental to the main bearing. Fig. 7 shows a schematic drawing of a TBM and the global coordinate system that defines the axis of the tunnel/machine (Z), the plane of the cutterhead (X–Y), the resultant force F_z , and the eccentricity D_E , which is defined as the distance of the resultant force from the center of the cutterhead.

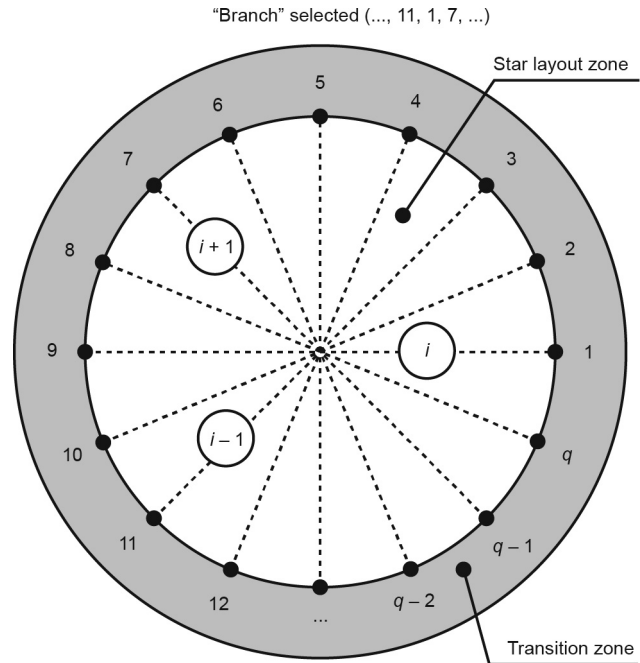

Fig. 10. Breaking down the cutterhead to q equal sections [9], where numbers 1 to q represent the subsections.

A good cutterhead design and cutter distribution avoids clustering of the cutters in any area of the head, and thus avoids eccentric forces and moments. Fig. 8 shows a normal and an exaggerated cutterhead with cutters clustered in the first quadrant (0°–90°).

The best and easiest approach to assign the location of the cutters on the cutterhead is to use the concept of angular spacing. This refers to using a polar (or cylindrical) coordinate system to allocate

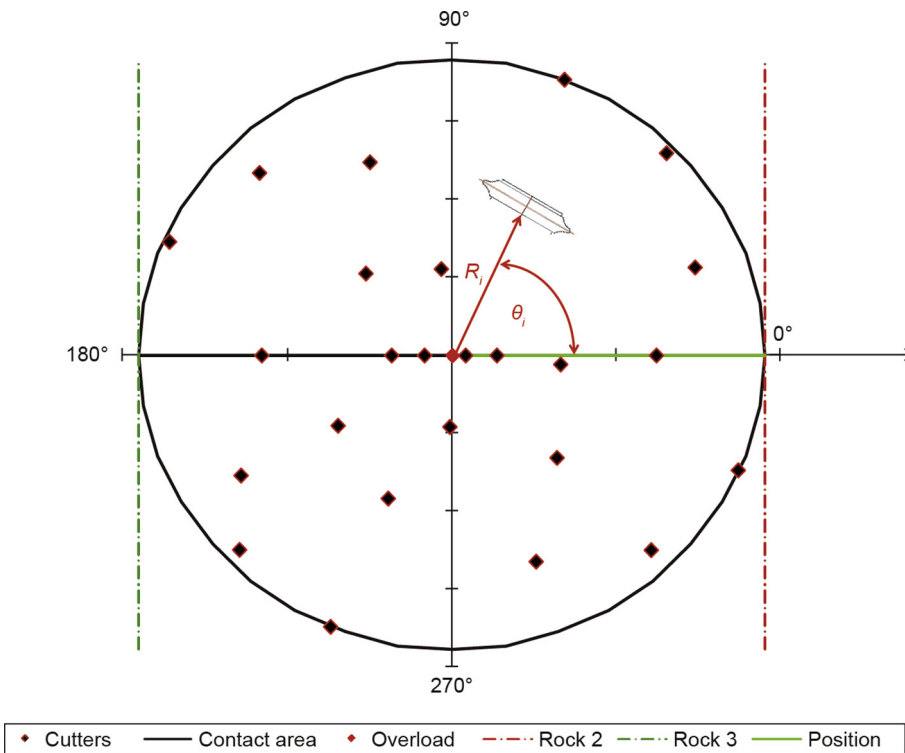

Fig. 9. Definition of the polar coordinate system for cutter allocation on the cutterhead.

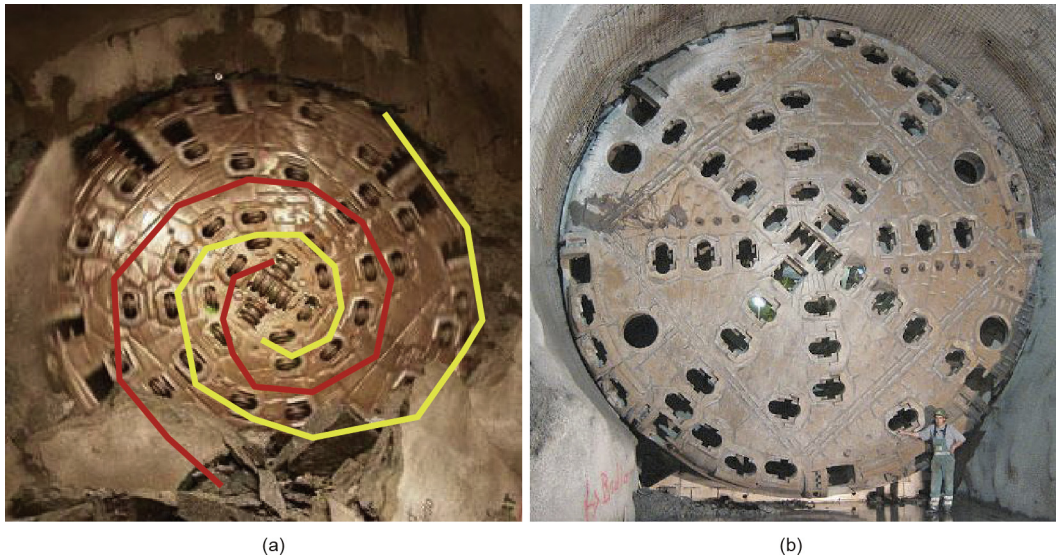

Fig. 11. Examples of cutterhead design and cutter lacing patterns: (a) double spiral; (b) 8 spoke.

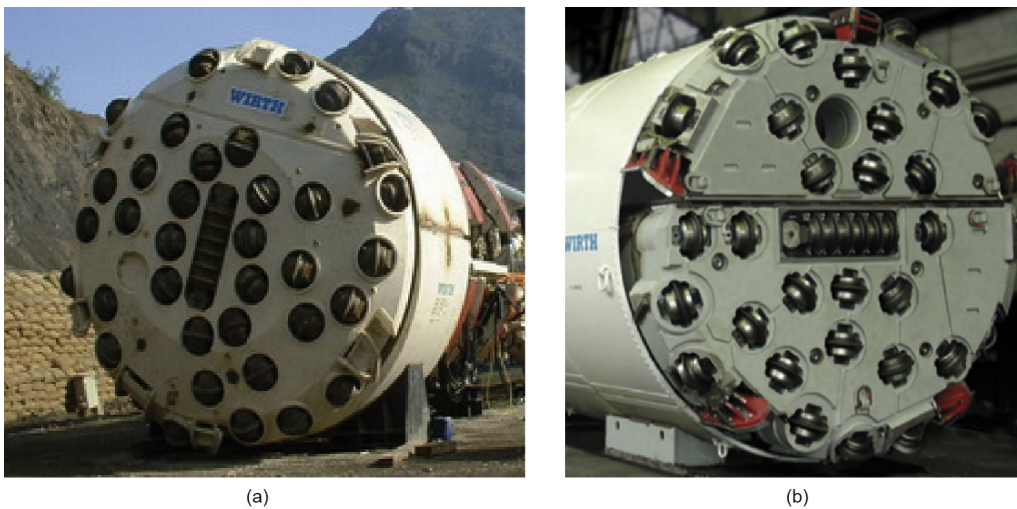

Fig. 12. Examples of cutterhead design: (a) random [24]; (b) cutter allocation with cutterhead joints.

cutters using the radius from the center and an angle relative to a reference line. The radius from the center is already defined by the profile, and the angle can be defined relative to an axis (i.e., the X axis). Thus, the location coordinates for a cutter will be (R_i, θ_i) in two-dimensional (2D) space or on a plane, or (R_i, θ_i, Z_i) in three-dimensional (3D) space or on a cylindrical coordinate system, as shown in Fig. 9. Given these parameters, it is possible to develop an algorithm for cutter distribution around the head using a program. That is, it is possible to define $\theta_{i+1} = f(\theta_i)$; for example, $\theta_{i+1} = \theta_i + \theta_s$, where θ_s is the angular spacing.

Using this methodology allows the distribution of the cutters on the head to be controlled. To avoid unbalanced cutter distribution around the head, the angular spacing used in the design should permit the optimal distribution of cutters around the head [9]. Another advantage of using this system is that it is possible to define this algorithm in a program in order to help the designer visualize the cutterhead design and various arrangements on the head.

General principles for good and optimized cutter distribution for the cutterhead design are as follows:

- A cutterhead should have a uniform distribution of cutters around the head. For example, if the cutterhead is broken into q sections (Fig. 10 [9]), the number of cutters in each section should ideally be the same. If this trend continues as q increases, there is a better distribution of cutters on the head. Of course, there are other limits on where to allocate the cutters on the head, which will be discussed later.
- The easiest way to achieve a good distribution is to try to maintain cutterhead symmetry as much as possible. This is easier to maintain when the number of cutters is an even number. Then for cutter i , there is a cutter $i + 1$ across the cutterhead and at the $\theta_{i+1} = \theta_i + 180^\circ$ angular position.
- It is preferable to avoid placing cutters over muck buckets, cutterhead joints, and cutterhead structure, if it is known.
- It is important to be cognizant of the minimum space required to fit a cutter on the head. In other words, the cutters should be able to physically fit the prescribed pattern.
- Although the designer attempts to create a uniform distribution and maintain symmetry, it is nearly impossible to obtain a fully symmetrical design and perfectly uniform distribution of

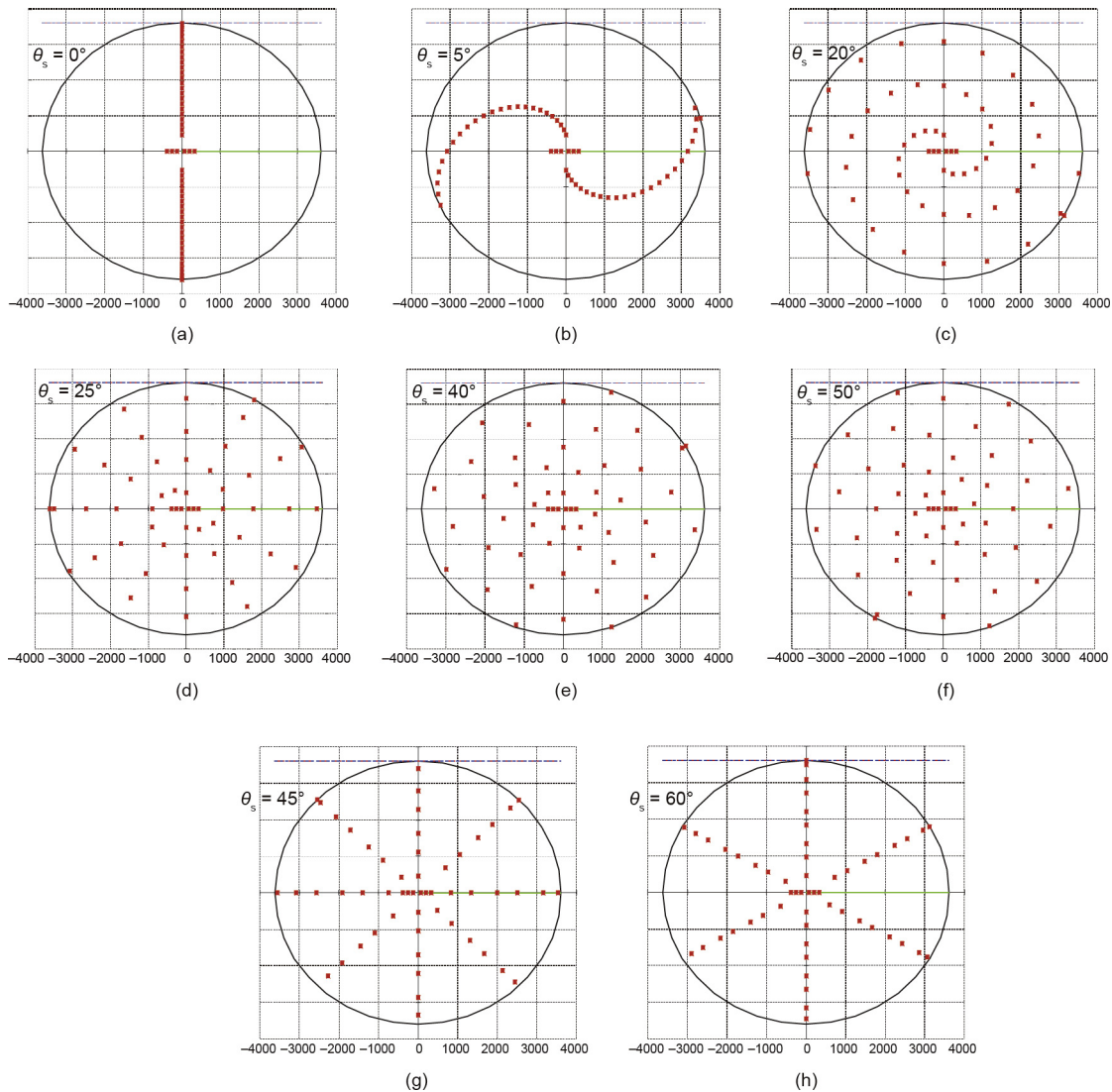

Fig. 13. Variation of the angular spacing and its impact on the design of the cutterhead in a double-spiral arrangement. The corresponding angular spacing is: (a) $\theta_s = 0^\circ$, (b) $\theta_s = 5^\circ$, (c) $\theta_s = 20^\circ$, (d) $\theta_s = 25^\circ$, (e) $\theta_s = 40^\circ$, (f) $\theta_s = 50^\circ$, (g) $\theta_s = 45^\circ$, and (h) $\theta_s = 60^\circ$.

cutters due to practical reasons. In such cases, the designer can use gage cutters to try to maintain the balance of the head and minimize the eccentric forces.

With these guidelines in mind, it is possible to either design a cutterhead or be able to check the balance of a given design. The available patterns for cutterhead designs can be divided into three categories as follows:

(1) **Spiral design.** Here, $\theta_i \sim R_i$, meaning that as the radius increases, the angular position will increase as well.[†] A double-/multi-spiral design can be developed using this algorithm but using angular spacing on every other cutter. An example is the double spiral $\theta_{i+1} = \theta_i + 180^\circ$ and $\theta_{i+2} = \theta_i + \theta_s$.

(2) **Spoke or star design.** Here, the cutters are aligned along radial lines at equal angular distances; for example: 3 spoke/star, 4 spoke, 6 spoke, 8 spoke, ..., where the cutters are placed on lines at a position angle of 120° , 90° , 60° , 45° , ..., respectively, from the reference line.

(3) **Random or asymmetrical design.** Here, the cutters are allocated based on the availability of the space, and do not follow a particular pattern.

Figs. 11 and 12 [24] show some examples of these design types. Once the cutterhead design type is selected, the cutter allocation can be defined. Next, once the cutter allocation in a pattern is identified, the designer can check for other constraints such as joints in the cutterhead, interference with buckets, and so forth, and make minor adjustments.

One important note to keep in mind is that the design of the cutterhead and the cutter allocation are not purely mathematical exercises as indicated in some publications, and that the result may be somewhat asymmetrical and unbalanced. At this stage, the design of the cutterhead is an interactive task between the selection of the number and location of the buckets and the adjustment of the location of the gage cutters to prevent interference with the buckets. This is done by manually changing the angular position of the cutters in this area to place them between the buckets or within the allowed space. The same logic applies to the cutterhead joints, where the cutterhead may be split into pieces to accommodate a certain size requirement for assembly, for transfer

[†] Keep in mind that in any of these algorithms, when $\theta_{i+1} = \theta_i + \theta_s > 360^\circ$, then 360° is subtracted from the estimated value and the design continues.

into the shaft or starter tunnel, or to contain the weight of the cutterhead in larger sized machines (Fig. 12(b)).

2.6. Muck buckets

The selection of the number, size, and allocation of the buckets is an integral part of the cutterhead design. The number and size of the buckets are proportional to the anticipated volume of material excavated, and increase with the expected ROP of the TBM in softer rocks. This is to accommodate efficient mucking and removal of the cut material from the face in order to avoid erosion of the face plate, wear of the cutters, and accumulation of muck and fines in the invert, the latter of which can cause excessive load on the gage cutters and premature failure. Another issue is the size of the opening of the buckets, which is somewhat controlled by the expected sizing of the muck and is selected to allow certain size blocks into the muck chutes. The typical range of material that is allowed to enter the chute is about 100 mm × 100 mm or 100 mm × 150 mm, as the upper limit of the size; blocks larger than this range are kept in the face to be broken by the disks. This is done by the face plate or face shield holding such blocks in the face.

Once the number of buckets is known, the buckets are systematically and evenly spread around the head; thus, their angular position will be determined as $360^\circ/N_{\text{Buckets}}$. This is to make sure the volume of muck picked up from the invert is uniform. In addition, there are some cases in which buckets of different lengths have been used. In these cases, some longer buckets were placed in between regular buckets (i.e., every second or every third bucket). The most common number of buckets is four for small cutterheads in very hard rock, six to eight for medium-sized machines, and more than 12 for machines larger than 9 m. The buckets are designed with respect to the softest formation along the tunnel in order to accommodate efficient mucking in the highest flow of material, whereas the cutter allocation and profile are selected with respect to the hardest formation along the alignment in order to ensure that the spacing of the cuts is not excessive, which would create a ridge between the cuts.

3. Cutterhead modeling

Some examples of programs using an algorithm for cutter distribution around the head are presented here. The basis for cutterhead modeling and for related spreadsheets is discussed elsewhere [7,8,25]. For this purpose, a 7.23 m diameter TBM that was studied for a project featuring 54 cutters is used to show the impact of various values of θ_s on the design of a double-spiral layout. It is interesting to see that even though the design is for a double spiral, it can be configured into a multi-star arrangement when reaching certain values of θ_s . In this example, θ_s is varied from 0, which involves theoretically lining up the cutters along the same line, to different values that will show the spread of the cutters around the head. The first six cutters are arranged in a cluster (position angles of 0° and 180°). The cutter angular position starts from cutter 7, which is set to sit at 90° , and cutter 8, which is set to be across the center (180° apart), at 270° . The other cutters will be shifted by θ_s , as can be seen in Fig. 13. A closer examination of the angles shows a repeating pattern at certain values of θ_s .

An interesting setting is the distribution of the cutters at $\theta_s = 30^\circ, 45^\circ, 60^\circ,$ and 90° , which corresponds with a 12, 8, 6, and 4 spoke cutterhead design pattern, respectively. Some examples of angular spacing forming a spoke pattern for 45° and 60° are shown in Fig. 13(g) and (h). Similarly, it is interesting to observe that the pattern can be completely uniform and symmetrical, that is, if $\theta_s = 40^\circ$ or 50° , as shown in Fig. 13. The algorithm permits fine-tuning of the cutterhead design to achieve the best distribution. A quick look at the design shows that in many patterns, buckets can be easily allocated without interference with the cutters. This is one of the advantages of using a fully symmetrical design. One of the spots close to the transition or near outer flanks of the face cutters can be designated as the location of the access or manhole for entry to the cutterhead. The location of the manhole is not prescribed, since it can be literally anywhere that a 0.5–0.6 m radius hole can be placed.

The difference in the performance of TBMs using cutterheads with different patterns in various conditions can be seen by cutterhead modeling, which will be discussed in the following section.

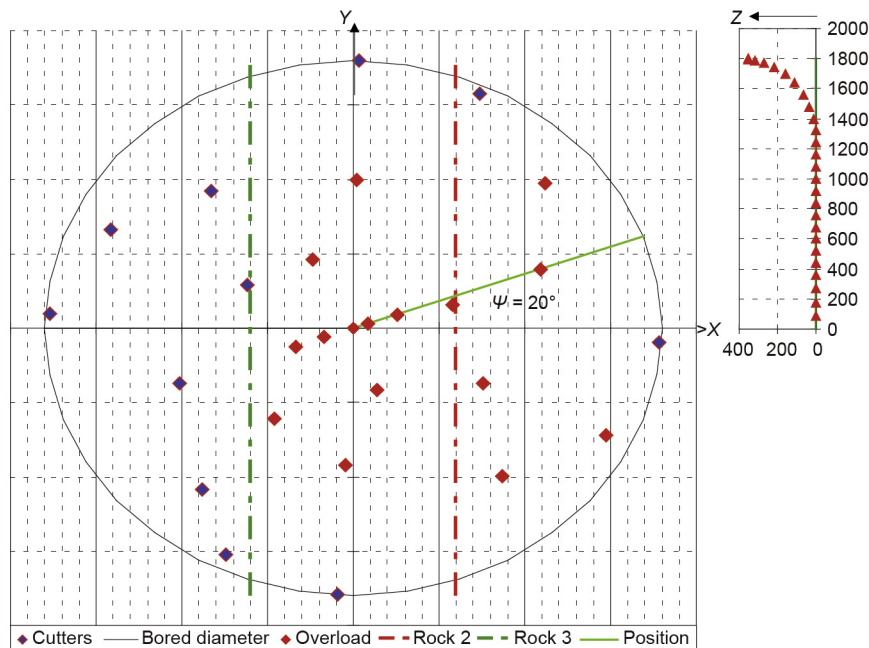

Fig. 14. Graphical representation of the cutterhead in computer modeling (units: mm).

Meanwhile, it is important to note that since the cutterhead is rotating, when the cutters are lined up in a spoke pattern, it is likely that quite a few of them will enter or exit a certain formation together, especially if the contact surfaces of different rocks are at the center of the cutterhead. This creates huge variations in the required forces and torques on the cutterhead, significant eccentric resultant force, and uneven loading of the main bearing.

4. Evaluation of cutterhead balance and vibration behavior

For a detailed analysis of cutterhead lacing, each cutter in the profile is analyzed individually and the overall interaction of the forces acting on individual cutters is considered in order to evaluate the cutterhead behavior. In this approach, the spatial locations of the cutters (e.g., the radius from the center, spacing from adjacent cuts and, eventually, true penetration) are considered in determining the cutting forces. These parameters are components of a cylindrical coordinate system (R, θ, Z). From these parameters,

true penetration and thus the cutting forces (F_{Ni}, F_{Ri}, F_{Si}) are estimated for each individual cutter. They are then projected onto a universal coordinate system (F_{Xi}, F_{Yi}, F_{Zi}). These forces can be summed as $F_Z = \sum F_{Zi}, F_X = \sum F_{Xi},$ and $F_Y = \sum F_{Yi},$ where the sum of forces along the Z axis will be the cutterhead thrust. Similarly, the moment for each cutter for the X, Y, and Z axes can be calculated from $F_{Xi}, F_{Yi},$ and F_{Zi} and the related $Xi, Yi,$ and Zi distances from the center. The sum of moments in the Z axis is the machine torque. Fig. 14 shows a graphical illustration of the cutterhead for a small 3.8 m diameter machine, as depicted in the program. In this figure, red and green dashed lines show the limits of various rock types in a mixed face condition. Red-colored markings indicate overloaded cutters. The program allows for rotation of the cutterhead, where the reference line used for the design can be moved using a nominal rotation angle ψ . The cutting forces are estimated using the CSM model, given the properties of different rock formations, cutter geometry, spacing, and true penetration for each individual cutter. This arrangement of the spreadsheet allows for a more detailed evaluation of the forces on individual cutters while

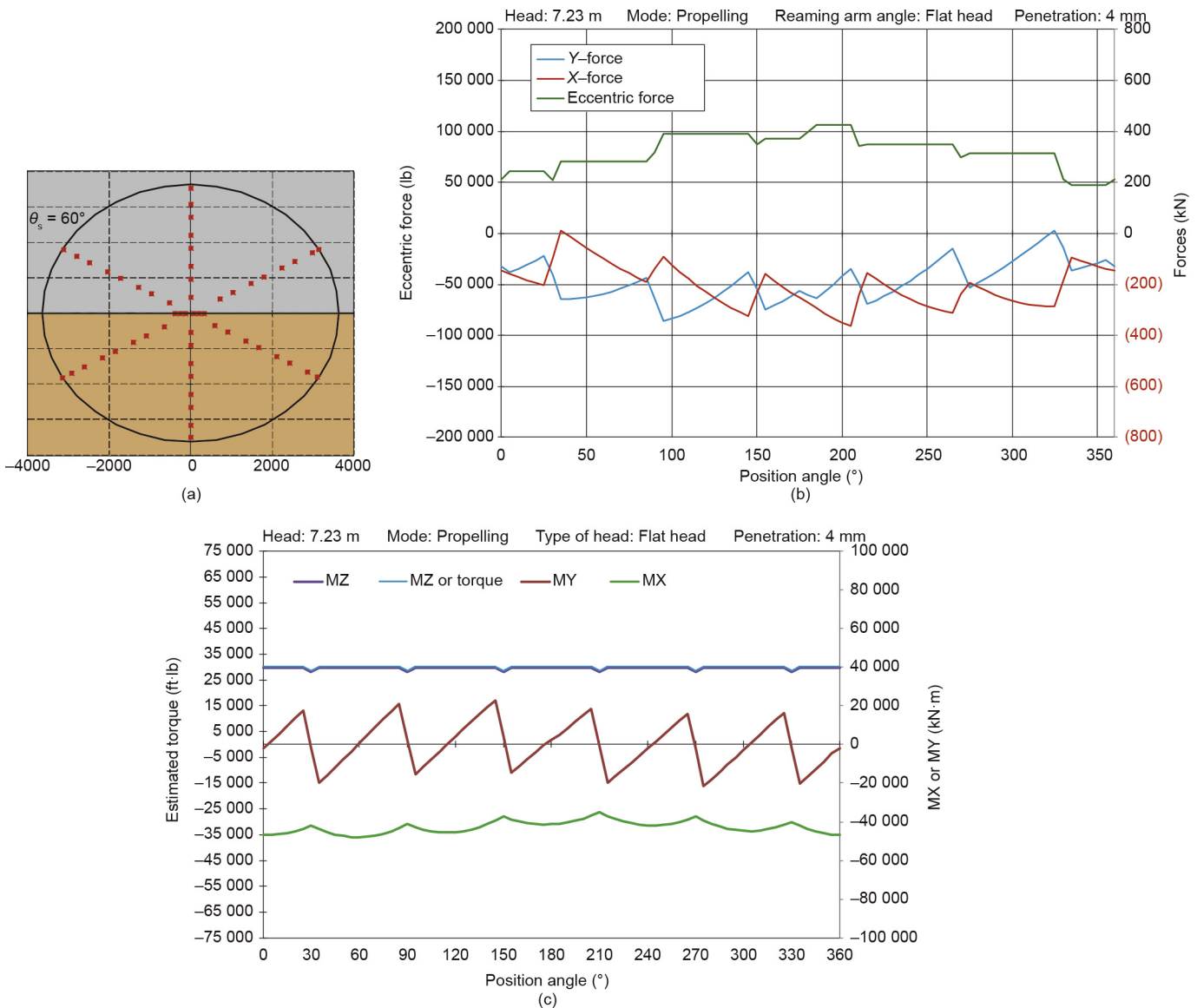

Fig. 15. (a) The distribution of the cutters at $\theta_s = 60^\circ$ and an example of variation of the estimated (b) eccentric forces and (c) moments for a lacing pattern using $\theta_s = 60^\circ$ in a mixed face with two rock types split at the middle of the face, for a 7.23 m diameter TBM. 1 lb = 0.453592 kg; 1 ft-lb = 1.3549 N-m. MX: moment in the X axis; MY: moment in the Y axis; MZ: moment in the Z axis.

providing the ability to change the cutterhead design and observe the effects of design issues on the force distribution across the face, total forces, and sum of moments.

The procedure permits the identification of potential problem areas where a cutter could be overloaded due to the lacing pattern, and can thus provide a warning. Overloading of a particular cutter can happen despite the fact that the overall thrust and corresponding estimated average cutterloads are well within the thrust limits and nominal capacity of the cutters, as set by the machine manufacturer. In the model, the cutting forces are estimated, a full vector analysis of the forces is performed, and the amount of eccentric forces and moments can be determined. This modeling system also allows for full rotation of the head relative to a reference line in the face, and provides a powerful tool for cutterhead optimization. The model runs for full rotation of the head by changing the value of ψ , and records the estimated cutterhead thrust, torque, power, and eccentric forces and moments.

The ideal situation and best cutterhead design are when the amount of eccentric forces (F_x and F_y) are zero and the only resultant force and moment are in line with the Z or tunnel/machine

axis. This situation is best for the main bearing and cutterhead support, while indicating a smooth operation with better alignment control. This situation is an ideal one, however; in reality, there are some levels of eccentricity in the forces, due to many factors. These include: the properties of dissimilar rock types at the face, joints, and fallouts; different wear patterns on the disks; and the accumulation of muck at the invert. However, a well-balanced cutterhead lacing can minimize these problems and provide better chances of survival for the main bearing as well as improved cutter life due to true tracking. The main bearing is typically designed to take 10%–15% of the nominal total thrust as eccentric force.

Cutterhead balancing at this stage is performed by evenly distributing the cutters around the head in order to achieve minimum eccentric forces; this is often achieved using cutterhead symmetry. For this purpose, cutterhead simulation allows fine tuning of the location of the gage cutters to achieve a balanced cutterhead in case of any interference with muck buckets or cutterhead joints. Detailed cutterhead modeling permits the objective evaluation of various designs and head patterns. It allows quantitative

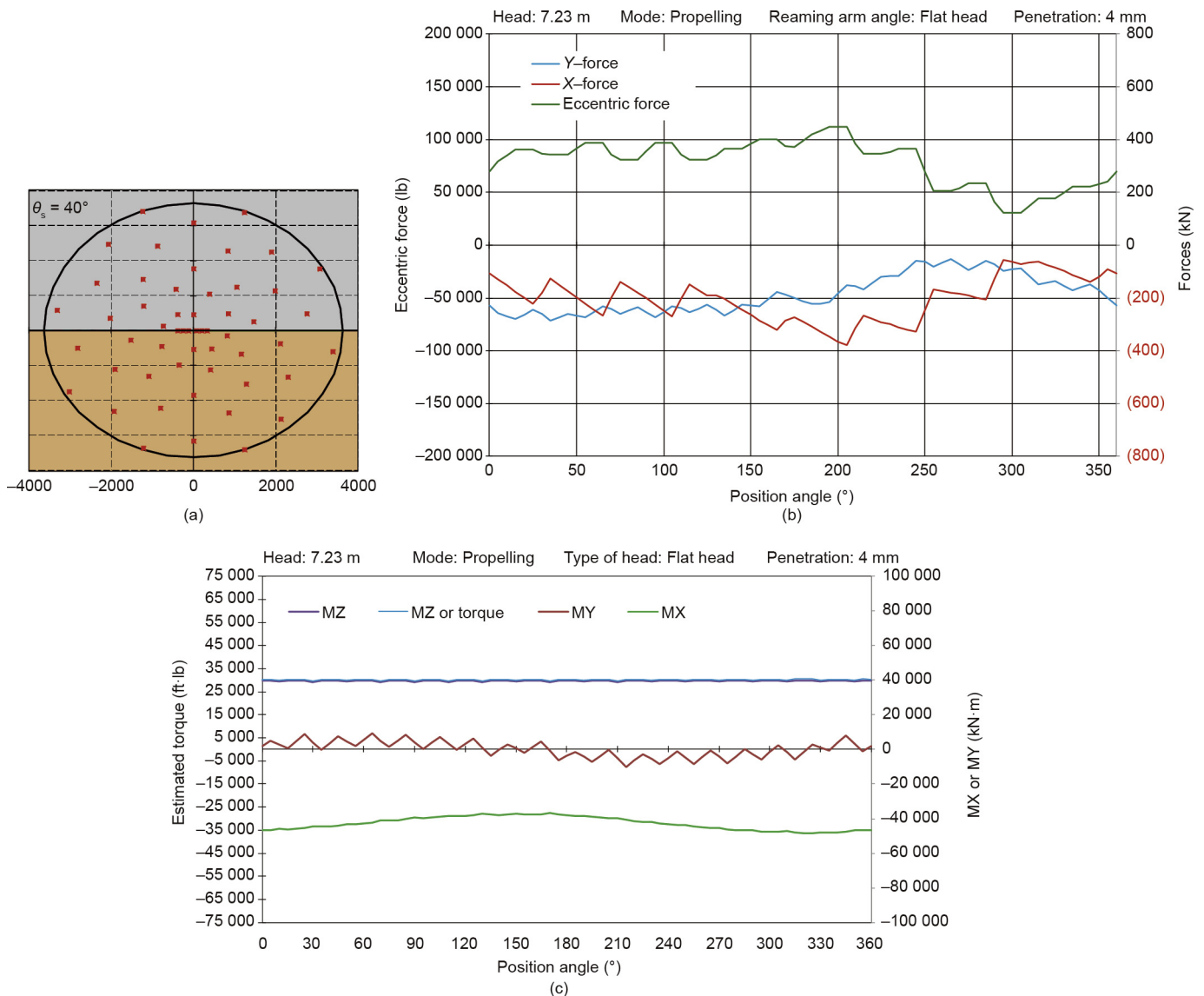

Fig. 16. (a) The distribution of the cutters at $\theta_s = 40^\circ$ and an example of variation of the estimated (b) eccentric forces and (c) moments for a lacing pattern using $\theta_s = 40^\circ$ in a mixed face with two rock types split at the middle of the face, for a 7.23 m diameter TBM.

comparison between different designs in any given geological setting. Although the variation of forces for a well-balanced cutterhead in a uniform face is minimal, the variability of forces and moments in mixed ground conditions could be significant. A major advantage of cutterhead modeling is its simulation of mixed ground conditions, in which dissimilar materials (soft and hard rock or rock and fault gouge, etc.) are present at the face. Programming the individual cutters allows the cutting forces in each rock type to be estimated, and thus provides the designer with actual forces in each section of the face. The highest contrast can be observed when the face is split between two formations (with highest differential strength) at the center. In this situation, the components of the eccentric forces and moments are at their maximum. An example of such a condition is given in Figs. 15 and 16. Accurate estimation and quantification of these parameters are essential to evaluate the potential of imbalanced forces on the main bearing, as these can inflict major damage on the main bearing and cutterhead.

A quick look at the figures shows that the lacing can impact the magnitude of the eccentric forces and moments, especially when dissimilar materials are cut at the face. In reality, it is very common to have some dissimilarity in the material at the face due to different lithologies, different locations of a joint or a joint set, variability in the strength of the rock, directional properties, anisotropy, and so forth. A comparison of Figs. 15 and 16 shows the impact of an even distribution of the cutters on the eccentric forces and moments, even in a fully symmetrical cutterhead design. Lower out-of-center forces and moments (in the *X* and *Y* directions) result in better loading conditions on the cutterhead and main bearing. Thus, a comparison of the magnitude of the forces and moments permits a quantitative evaluation of the performance of various designs.

5. Conclusions

This paper is a summary of the principal concepts involved in the design of cutterheads for hard rock TBMs. The general approach for developing an optimum design has been described in a step-by-step manner. Some design patterns were presented and their implications shown using various examples. It is necessary to keep in mind that the cutterhead will experience unbalanced forces and moments irrespective of the head design; however, uniform distribution of the cutters will minimize the variation of the eccentric forces and out-of-axis moments. An optimum design of the cutterhead will reduce the out-of-axis loading of the bearing, reduce the side forces on the cutters, and generally improve the performance of the machine; it will also reduce the maintenance requirements of the cutters, cutterhead, and drive system. The importance of cutterhead balance is paramount, and design optimization can be done using computer models that allow for variation of the design and evaluation of the forces and moments acting on the cutterhead. These models permit the simulation of various cutting scenarios and their impact on the forces, torque, power, and cutterloads. They can be used to compare various cutterhead design patterns for application under certain working conditions, and to identify possible modifications. These models also allow the estimation of the anticipated forces acting on individual cutters as well as examination of the forces and moments (including cutterhead torque) acting on the entire cutterhead or main bearing under various conditions. The result of a well-designed cutterhead is improved machine performance through higher ROP, low cutter and cutterhead maintenance, and higher machine utilization.

Compliance with ethics guidelines

Jamal Rostami and Soo-Ho Chang declare that they have no conflict of interest or financial conflicts to disclose.

References

- [1] Ates U, Bilgin N, Copur H. Estimating torque, thrust and other design parameters of different type TBMs with some criticism to TBMs used in Turkish tunneling projects. *Tunn Undergr Space Technol* 2014;40:46–63.
- [2] Snyder LL. New design of hard rock TBMs. In: *Proceedings of 1989 rapid excavation and tunnelling conference*. Littleton: Society for Mining, Metallurgy, and Exploration, Inc.; 1989. p. 756–67.
- [3] Sun W, Ling J, Huo J, Guo L, Song X. Study of TBM cutterhead fatigue damage mechanisms based on a segmented comprehensive failure criterion. *Eng Failure Anal* 2015;58(Pt 1):64–82.
- [4] Genga Q, Wei Z, Menga H, Maciasb FJ. Mechanical performance of TBM cutterhead in mixed rock ground conditions. *Tunn Undergr Space Technol* 2016;57:76–84.
- [5] Lee SW, Chang SH, Park KH, Kim CY. TBM performance and development state in Korea. *Procedia Eng* 2011;14:3170–5.
- [6] Cho JW, Jeon S, Yu SH, Chang SH. Optimum spacing of TBM disc cutters: A numerical simulation using the three-dimensional dynamic fracturing method. *Tunn Undergr Space Technol* 2010;25(3):230–44.
- [7] Rostami J, Ozdemir L. Computer modeling for cutterhead design and layout of mechanical excavators. In: *Proceedings of the 12th annual technical meeting of the institute of shaft drilling technology*; 1993 May 3–5; Las Vegas, NV, USA. 1993. p. 2–6.
- [8] Rostami J. Hard rock TBM cutterhead modeling for design and performance prediction. *Geomech Tunn* 2008;1(1):18–28.
- [9] Huo J, Sun W, Chen J, Zhang X. Disc cutters plane layout design of the full-face rock tunnel boring machine (TBM) based on different layout patterns. *Comput Ind Eng* 2011;61(4):1209–25.
- [10] Rostami J. Rock cutting tools for mechanical mining. In: *Proceedings of society for mining, metallurgy and exploration (SME) annual meeting*. Littleton: Society for Mining, Metallurgy, and Exploration, Inc.; 2001.
- [11] Rostami J. Disc cutter technology for hard rock tunneling. *Tunnels Tunnelling Int* 1998 Apr:42–4.
- [12] Roby J, Sandell T, Kocab J, Lindbergh L. The current state of disc cutter design and development directions. *Tunnel Undergr Constr* 2009 Mar:36–45.
- [13] The Niagara tunnel project [Internet]. Solon: The Robbins Company; [cited 2017 Oct 26]. Available from: <http://www.therobbinscompany.com/projects/niagara-tunnel-project/>.
- [14] Rostami J. Development of a force estimation model for rock fragmentation with disc cutters through theoretical modeling and physical measurement of crushed zone pressure [dissertation]. Golden: Colorado School of Mines; 1997.
- [15] Rostami J. Study of pressure distribution within the crushed zone in the contact area between rock and disc cutters. *Int J Rock Mech Min* 2013;57:172–86.
- [16] Chang SH, Choi SW, Bae GJ, Jeon S. Performance prediction of TBM disc cutting on granitic rock by the linear cutting test. *Tunn Undergr Space Technol* 2006;21(3–4):271.
- [17] Sanio HP. Prediction of the performance of disc cutters in anisotropic rock. *Int J Rock Mech Min* 1985;22(3):153–61.
- [18] Sato K, Gong F, Itakura K. Measurement of tool force and twist exerted on TBM disc cutters. In: *Proceedings of 2nd international symposium on mine mechanization and automation*. Rotterdam: A.A. Balkema; 1993. p. 271–8.
- [19] Sato K, Gong F, Itakura K. Prediction of disc cutter performance using a circular rock cutting rig. In: *Proceedings of 1st international symposium on mine mechanization and automation*. Golden: Colorado School of Mines; 1991. p. 31–40.
- [20] Gertsch R, Gertsch L, Rostami J. Disc cutting tests in Colorado Red Granite: Implications for TBM performance prediction. *Int J Rock Mech Min* 2007;44(2):238–46.
- [21] Medel-Morales RC, Botello-Rionda S. Design and optimization of tunnel boring machines by simulating the cutting rock process using the discrete element method. *Computación y Sistemas* 2013;17(3):329–39.
- [22] Willis D. Main beam TBM makes great time in Mumbai [Internet]. *TunnelTalk*; 2014 Feb 25 [cited 2017 Nov 29]. Available from: <http://www.tunneltalk.com/Mumbai-India-25Feb14-Robbins-main-beam-TBM-makes-great-time-in-Mumbai.php>.
- [23] Bruland A. Hard rock tunnel boring [dissertation]. Trondheim: Norwegian University of Science and Technology; 1998.
- [24] Alborz exploration tunnel [Internet]. Schruns: Jäger Bau GmbH; [cited 2017 Nov 26]. Available from: <http://www.jaegerbau.com/en/underground-construction/special-underground-projects/reference-projects/alborz-exploration-tunnel/>.
- [25] Cigla M, Ozdemir L. Computer modeling for improved production of mechanical excavators. In: *Proceedings of society for mining, metallurgy and exploration (SME) annual meeting*. Littleton: Society for Mining, Metallurgy, and Exploration, Inc.; 2000.